

CODE	NAME	DN
2100.107	Butynol Dropper 300x80	80

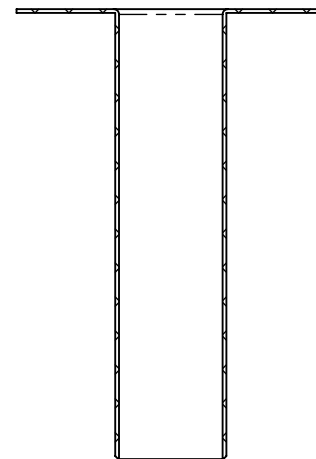
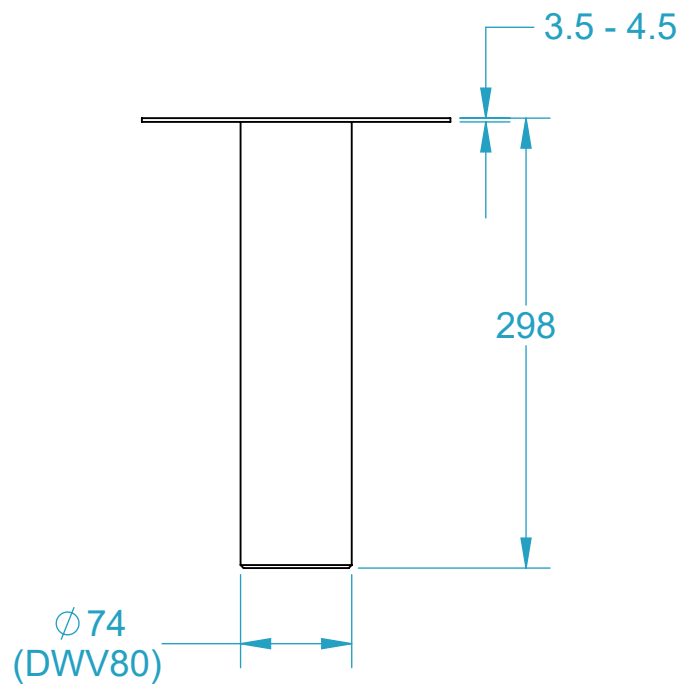
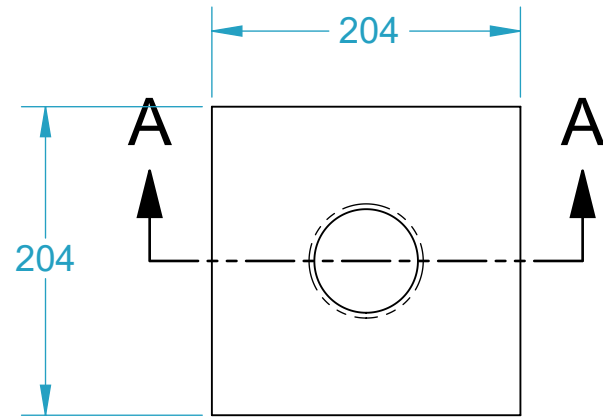

SECTION A-A