

CODE	NAME	DN
2100.109	Butynol Dropper 300x150	150

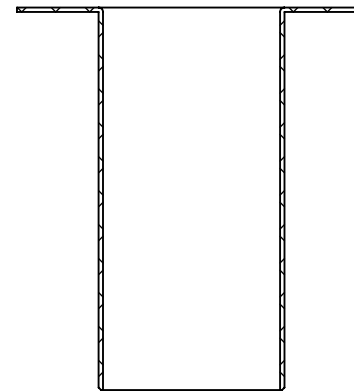
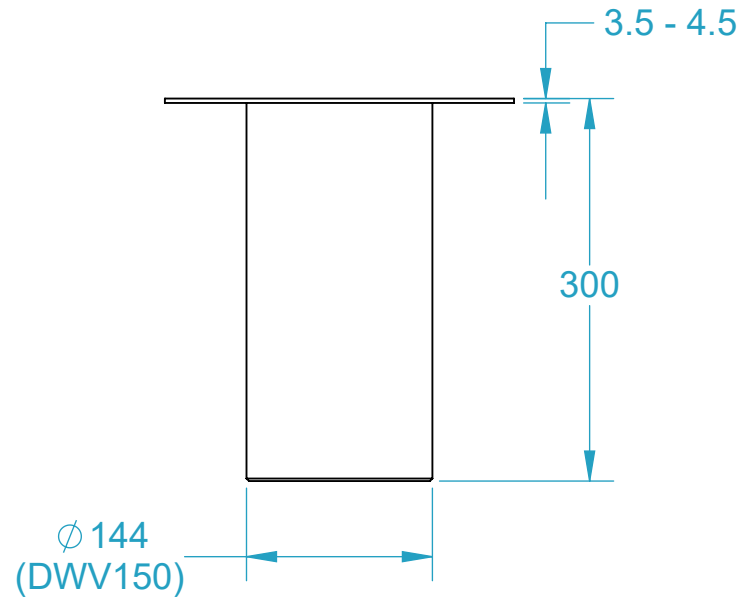
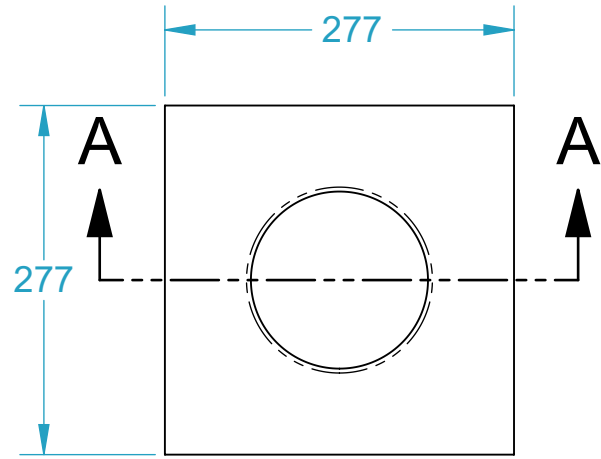

SECTION A-A